



POOL BREAKDOWN

8" SERIES 18' ROUND 54" RESIN TOP RAIL - RESIN VERTICAL - RESIN BOTTOM RAIL

√	QTY	CARTON NUMBER	CARTON DESCRIPTION
	1	5-9918-842	ASSEMBLY PACK CARTON
	1	5-9812-726	TOP RAIL PACK CARTON
	1	5-9712-726	VERTICAL PACK CARTON
	1	5-XXXX-018	SIDEWALL CARTON
	1	5-9999-512	TOP CONNECTOR PACK



CARTON BREAKDOWN

✓	ITEM	QTY	PART NUMBER	DESCRIPTION
ASSEMBLY PACK # 5-9918-842				
	1	9	583-1070	Stabilizer Rail (Large)
	2	9	583-1071	Stabilizer Rail (Small)
	3	12	580-2407	Bottom connector
	4	12	580-2408	Vertical end cap
	6	31	545-1001	Plastic coping
	7	12	589-1299P	Bottom rail
	17	120	330-1127	Sheet metal screw, #10 x 1/2"
	22	12	580-2397	Vertical tab
	23	12	330-1075	Pan head screw #14 x 1/2"
	—	1	573-5597	Pool Parts List
	—	1	573-4047	Installation Instructions
	—	1	— — —	Warranty Card
	—	1	573-3169	"Safety First" Booklet

TOP CONNECTOR PACK # 5-9999-512				
	5	12	340-2116	Top connector

TOP RAIL PACK # 5-9812-726				
	25	12	587-1741	Top Rail

VERTICAL PACK # 5-9712-726				
	27	12	341-1508	Vertical

SIDEWALL CARTON				
	38	1	5-XXXX-018	Sidewall
	39	1	535-1442	Protective Strip
	40	27	321-1029	1/4-20 Hex Flange Locknut
	41	27	330-1280	1/4-20 x 1/2" Grade 5 Bolt
	—	1	560-1055	Warning Sign
	—	1	573-3169	"Safety First" Booklet
	—	1	573-3498	Safety DVD

WRITE SIDEWALL NUMBER HERE _____

WRITE SIDEWALL BOX SERIAL NUMBER HERE _____

EXPLODED PARTS VIEW

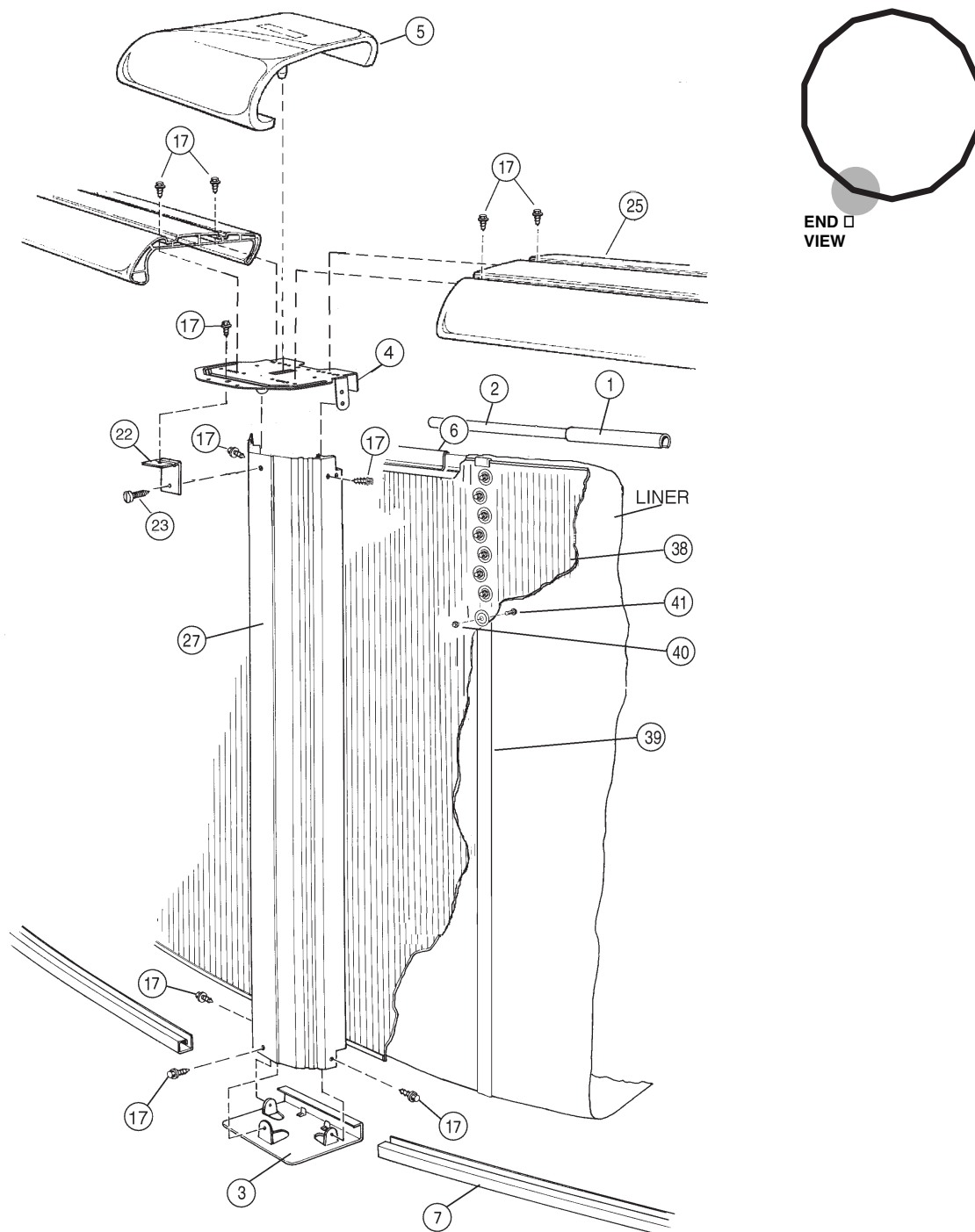

Important! Above-ground pools are designed for swimming and wading only. Do not Dive or Jump! Misuse of your pool may result in crippling injury and/or other dangers to life and health. Do not use slides, diving boards, or any other platform or object which can be used for improper pool entry. Use only an above-ground swimming pool ladder or entry system to enter or exit your pool. Never attempt to swim or reach behind ladders or any other pool entry system. It is the pool owner's responsibility to secure the pool against unauthorized, unsupervised or unintentional entry. It is also the pool owner's responsibility to warn all pool users of the hazards of diving into shallow water: paralyzing injury may result. Always obey all safety rules. Remember, pool safety is everybody's responsibility.

Safety decals and caution information provided with your pool have been endorsed by the U.S. Consumer Product Safety Commission. It is mandatory that the pool owner and installer follow the installation and use directions for all provided safety signs and decals. Juveniles must be supervised at all times by a responsible adult as directed by the USCPSC.

Change of Design: The manufacturer (Hill) expressly reserves the right to change or modify the design and construction of any product in due course of their manufacturing procedures, without incurring any obligation to furnish or install such changes or modifications on products previously or subsequently sold.