



POOL BREAKDOWN

8" SERIES 27' ROUND 54" RESIN TOP RAIL - RESIN VERTICAL - RESIN BOTTOM RAIL

√	QTY	CARTON NUMBER	CARTON DESCRIPTION
	1	5-9927-842	ASSEMBLY PACK CARTON
	1	5-9818-726	TOP RAIL PACK CARTON
	1	5-9718-726	VERTICAL PACK CARTON
	1	5-XXXX-027	SIDEWALL CARTON
	1	5-9999-518	TOP CONNECTOR PACK



CARTON BREAKDOWN

✓	ITEM	QTY	PART NUMBER	DESCRIPTION
ASSEMBLY PACK # 5-9927-842				
	1	12	583-1069	Stabilizer Rail (Large)
	2	12	583-1068	Stabilizer Rail (Small)
	3	18	580-2407	Bottom connector
	4	18	580-2408	Vertical end cap
	5	45	545-1001	Plastic coping
	6	18	589-1300P	Bottom rail
	11	180	330-1127	Sheet metal screw, #10 x 1/2"
	12	18	580-2397	Vertical tab
	13	18	330-1075	Pan head screw #14 x 1/2"
	—	1	573-5603	Pool Parts List
	—	1	573-4047	Installation Instructions
	—	1	— — —	Warranty Card
	—	1	573-3169	"Safety First" Booklet

TOP CONNECTOR PACK # 5-9999-518				
	5	18	340-2116	Top connector

TOP RAIL PACK # 5-9818-726				
	25	18	587-1741	Top Rail

VERTICAL PACK # 5-9718-726				
	27	18	341-1508	Vertical

SIDEWALL CARTON				
	38	1	5-XXXX-027	Sidewall
	39	1	535-1442	Protective Strip
	40	27	321-1029	1/4-20 Hex Flange Locknut
	41	27	330-1280	1/4-20 x 1/2" Grade 5 Bolt
	—	1	560-1055	Warning Sign
	—	1	573-3169	"Safety First" Booklet
	—	1	573-3498	Safety DVD

WRITE SIDEWALL NUMBER HERE _____

WRITE SIDEWALL BOX SERIAL NUMBER HERE _____

EXPLODED PARTS VIEW

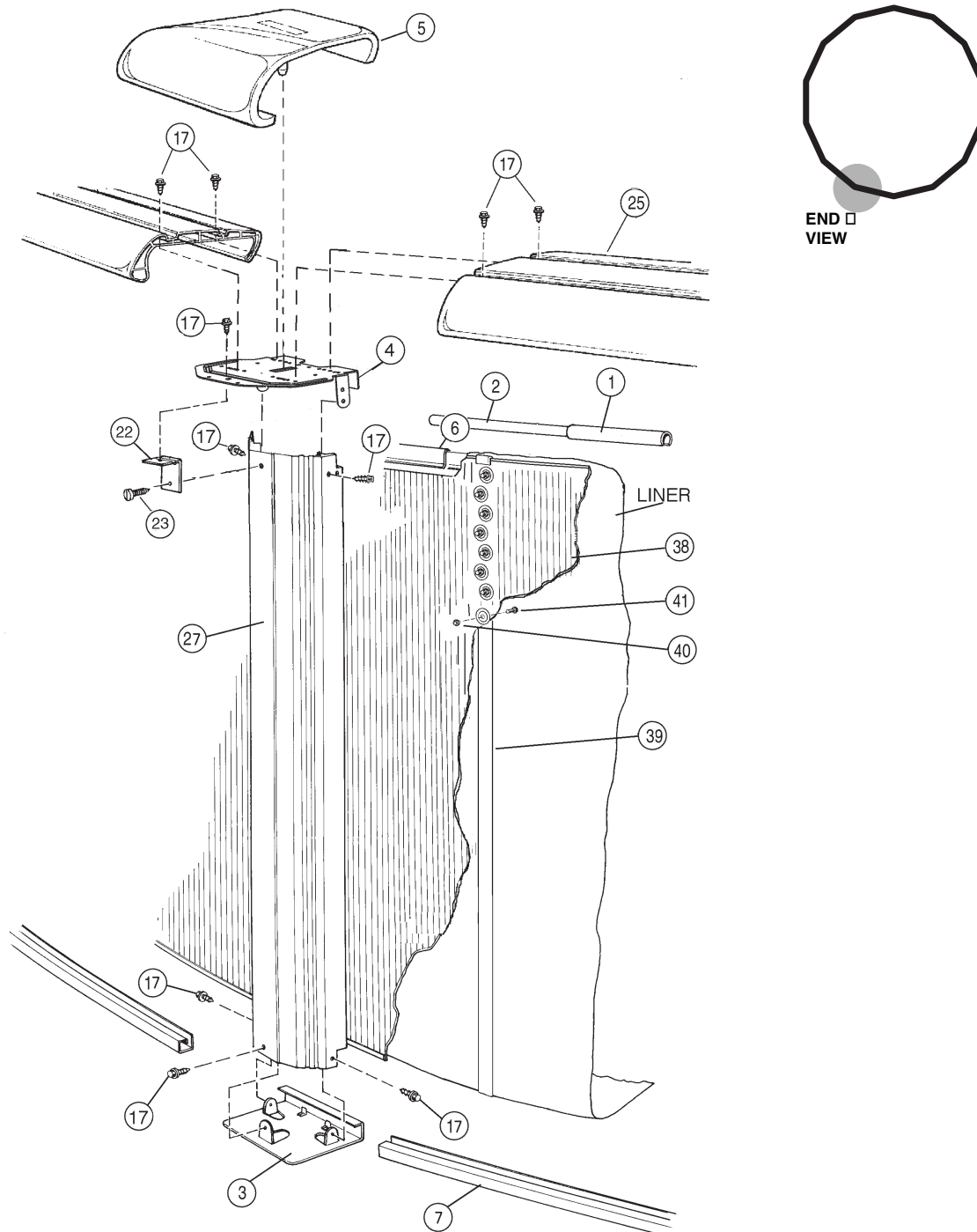

Important! Above-ground pools are designed for swimming and wading only. Do not Dive or Jump! Misuse of your pool may result in crippling injury and/or other dangers to life and health. Do not use slides, diving boards, or any other platform or object which can be used for improper pool entry. Use only an above-ground swimming pool ladder or entry system to enter or exit your pool. Never attempt to swim or reach behind ladders or any other pool entry system. It is the pool owner's responsibility to secure the pool against unauthorized, unsupervised or unintentional entry. It is also the pool owner's responsibility to warn all pool users of the hazards of diving into shallow water: paralyzing injury may result. Always obey all safety rules. Remember, pool safety is everybody's responsibility.

Safety decals and caution information provided with your pool have been endorsed by the U.S. Consumer Product Safety Commission. It is mandatory that the pool owner and installer follow the installation and use directions for all provided safety signs and decals. Juveniles must be supervised at all times by a responsible adult as directed by the USCPSC.

Change of Design: The manufacturer (Hill) expressly reserves the right to change or modify the design and construction of any product in due course of their manufacturing procedures, without incurring any obligation to furnish or install such changes or modifications on products previously or subsequently sold.