



POOL BREAKDOWN

7" SERIES 21' ROUND 52" RESIN TOP RAIL - RESIN VERTICAL - RESIN BOTTOM RAIL

√	QTY	CARTON NUMBER	CARTON DESCRIPTION
	1	5-9921-760	ASSEMBLY PACK CARTON
	1	5-9821-734	TOP RAIL PACK CARTON
	1	5-9714-712	VERTICAL PACK CARTON
	1	5-XXXX-021	SIDEWALL CARTON
	1	5-9114-702	SKIRT PACK CARTON
	1	5-9999-1014	TOP CONNECTOR PACK



CARTON BREAKDOWN

✓	ITEM	QTY	PART NUMBER	DESCRIPTION
TOP RAIL PACK # 5-9821-734				
	1	14	587-1760	Top Rail

SKIRT PACK # 5-9114-702				
	2	14	340-2610	Vertical skirt
	3	28	330-1023	Hex washer head screw #8 x 5/8"
	4	28	330-1127	Sheet metal screw, #10 x 1/2"

ASSEMBLY PACK # 5-9921-760				
	5	10	583-1069	Stabilizer Rail (Large)
	6	10	583-1068	Stabilizer Rail (Small)
	7	28	580-2426	Vertical End Cap
	8	14	580-2128	Outer connector bracket
	10	35	545-1001	Plastic coping
	11	14	589-1257P	Bottom rail - stamped 21 C
	16	126	330-1127	Sheet metal screw, #10 x 1/2"
	17	14	510-1038	Machine screw #6-32 x 1/2"
	18	14	321-1088	Hex nut #6-32
	—	1	573-5497	Pool Parts List
	—	1	573-3645	Installation Instructions
	—	1	— — —	Warranty Card
	—	1	573-3169	"Safety First" Booklet

TOP CONNECTOR PACK # 5-9999-1014				
	9	14	340-2645	Top connector

VERTICAL PACK # 5-9714-712				
	19	14	341-1485	Vertical

SIDEWALL CARTON				
	28	1	5-XXXX-021	Sidewall
	29	27	330-1280	1/4-20 x 1/2" Grade 5 Bolt
	30	27	321-1029	1/4-20 Hex Flange Locknut
	31	1	535-1442	Protective Strip
	—	1	560-1055	Warning Sign
	—	1	573-3169	"Safety First" Booklet
	—	1	573-3498	Safety DVD

WRITE SIDEWALL NUMBER HERE _____

WRITE SIDEWALL BOX SERIAL NUMBER HERE _____

EXPLODED PARTS VIEW

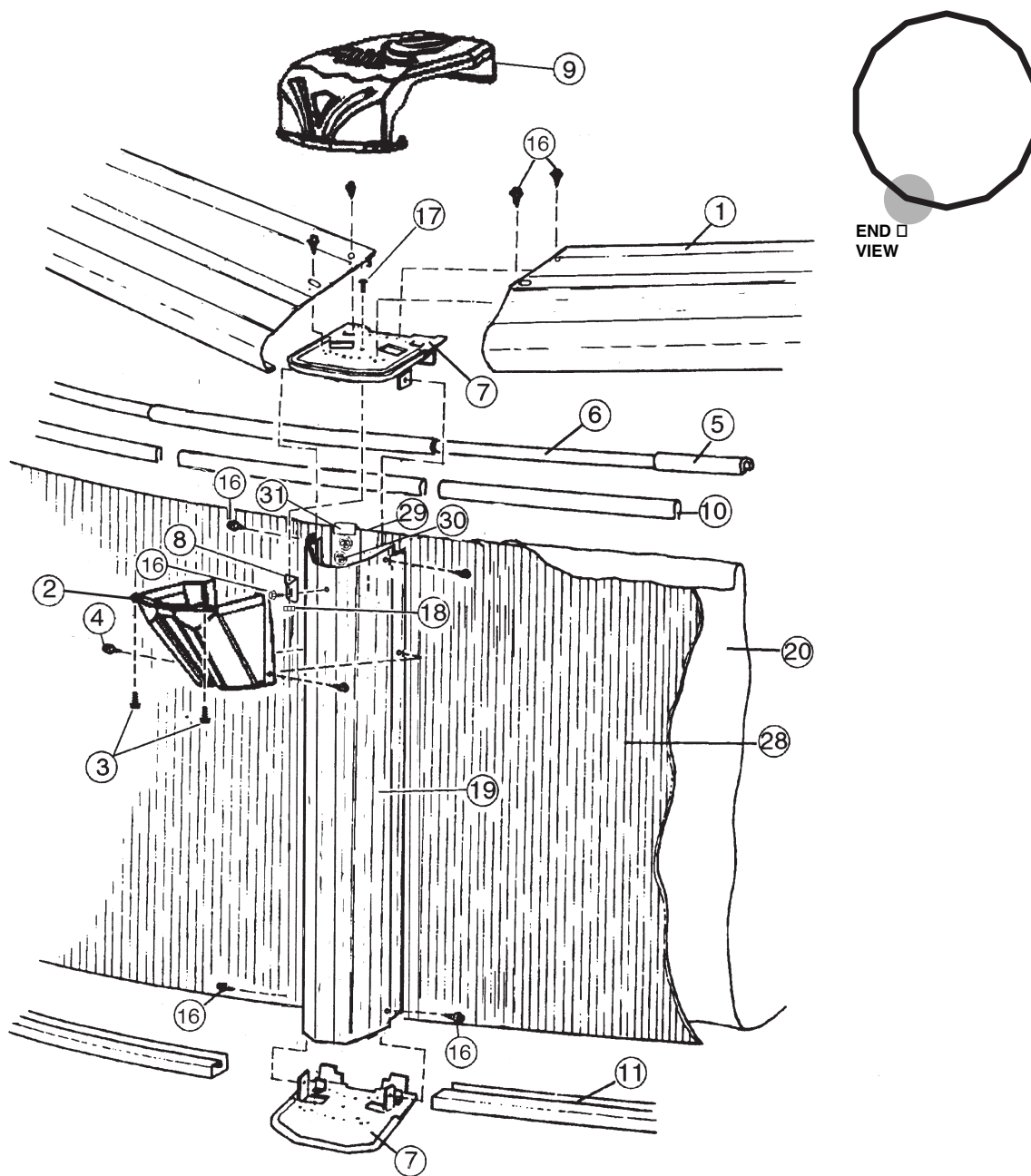

Important! Above-ground pools are designed for swimming and wading only. Do not Dive or Jump! Misuse of your pool may result in crippling injury and/or other dangers to life and health. Do not use slides, diving boards, or any other platform or object which can be used for improper pool entry. Use only an above-ground swimming pool ladder or entry system to enter or exit your pool. Never attempt to swim or reach behind ladders or any other pool entry system. It is the pool owner's responsibility to secure the pool against unauthorized, unsupervised or unintentional entry. It is also the pool owner's responsibility to warn all pool users of the hazards of diving into shallow water: paralyzing injury may result. Always obey all safety rules. Remember, pool safety is everybody's responsibility.

Safety decals and caution information provided with your pool have been endorsed by the U.S. Consumer Product Safety Commission. It is mandatory that the pool owner and installer follow the installation and use directions for all provided safety signs and decals. Juveniles must be supervised at all times by a responsible adult as directed by the USCPSC.

Change of Design: The manufacturer (Hill) expressly reserves the right to change or modify the design and construction of any product in due course of their manufacturing procedures, without incurring any obligation to furnish or install such changes or modifications on products previously or subsequently sold.